

A Accessories

Common Accessories

Contact Blocks and LED Blocks for Ø16 Control Switches

Ordering Information



SA	16	CB	W		
Item	Applied switches	Type	LED color ^{※1}	LED block	
				R	Red
				B	Blue
				G	Green
				Y	Yellow
					CB^{※2}
			Contact block	B contact (normally closed)	
				C contact (normally open, normally closed)	
			L5	5VDC	
			L12	12VDC	
		L24	24VDC		
		16	For Ø16 control switches		
		SA	Switch Accessories		

※1. Only for LED blocks.

※2. Only for Ø16 emergency switches.

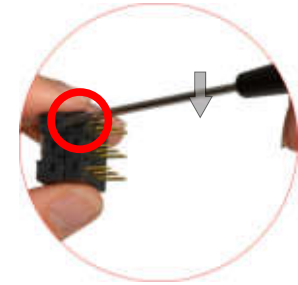
- **Contact block and LED block removal**
Separate the unit using a flat-head (-) screwdriver.



Item	Appearance	Model	Type	Features
Contact block		SA16-CB	B contact (normally closed)	For Ø16 emergency switches
		SA16-CC	C contact (normally open, normally closed)	—
LED block		SA16-L5□ (5VDC) SA16-L12□ (12VDC) SA16-L24□ (24VDC)	DC voltage type	Diverse, vibrant, high luminance LEDs (red, blue, green, yellow, white)

■ Contact Blocks and LED Blocks for Ø22/25, Ø30, □30 Control Switches

● Ordering Information

SA	-	CA	M												
Item				Contact block type	<table border="1" style="width: 100%; border-collapse: collapse;"> <tr><td style="width: 20%; text-align: center;">No-mark</td><td>Singular type</td></tr> <tr><td style="text-align: center;">M</td><td>Modular type</td></tr> </table>	No-mark	Singular type	M	Modular type						
No-mark	Singular type														
M	Modular type														
Applied switches				LED color ^{※1}	<table border="1" style="width: 100%; border-collapse: collapse;"> <tr><td style="width: 20%; text-align: center;">No-mark</td><td>White</td></tr> <tr><td style="text-align: center;">R</td><td>Red</td></tr> <tr><td style="text-align: center;">B</td><td>Blue</td></tr> <tr><td style="text-align: center;">G</td><td>Green</td></tr> <tr><td style="text-align: center;">Y</td><td>Yellow</td></tr> </table>	No-mark	White	R	Red	B	Blue	G	Green	Y	Yellow
No-mark	White														
R	Red														
B	Blue														
G	Green														
Y	Yellow														
Type				Contact block	<table border="1" style="width: 100%; border-collapse: collapse;"> <tr><td style="width: 20%; text-align: center;">CA</td><td>A contact (normally open)</td></tr> <tr><td style="text-align: center;">CB</td><td>B contact (normally closed)</td></tr> <tr><td style="text-align: center;">LD</td><td>AC/DC voltage type 12-24VAC 50/60Hz 12-24VDC</td></tr> <tr><td style="text-align: center;">LA</td><td>AC voltage type 110-240VAC 50/60Hz</td></tr> </table>	CA	A contact (normally open)	CB	B contact (normally closed)	LD	AC/DC voltage type 12-24VAC 50/60Hz 12-24VDC	LA	AC voltage type 110-240VAC 50/60Hz		
CA	A contact (normally open)														
CB	B contact (normally closed)														
LD	AC/DC voltage type 12-24VAC 50/60Hz 12-24VDC														
LA	AC voltage type 110-240VAC 50/60Hz														
Item				LED block	<table border="1" style="width: 100%; border-collapse: collapse;"> <tr><td style="width: 20%; text-align: center;">No-mark</td><td>For Ø22/25, Ø30, □30 control switches</td></tr> <tr><td style="text-align: center;">SA</td><td>Switch Accessories</td></tr> </table>	No-mark	For Ø22/25, Ø30, □30 control switches	SA	Switch Accessories						
No-mark	For Ø22/25, Ø30, □30 control switches														
SA	Switch Accessories														

● **Contact block and LED block removal**
Separate the unit using a flat-head (-) screwdriver.



※1. Only for LED blocks.

※Multi-unit connection is only available for modular type (SA-□M).

Item	Appearance	Model	Type	Features
Modular type contact block		SA-CAM	A contact (normally open)	Ring or spade terminals / Multi-connection (up to 3 units)
		SA-CBM	B contact (normally closed)	
Singular type contact block		SA-CA	A contact (normally open)	Spade terminals only / Loose screw prevention
		SA-CB	B contact (normally closed)	
Modular type LED block		SA-LD□M	AC/DC voltage type 12-24VAC 50/60Hz 12-24VDC	Diverse, vibrant, high luminance LEDs (Red, Blue, Green, Yellow, White)
		SA-LA□M	AC voltage type 110-220VAC 50/60Hz	
Singular type LED block		SA-LD□	AC/DC voltage type 12-24VAC 50/60Hz 12-24VDC	
		SA-LA□	AC voltage type 110-220VAC 50/60Hz	

Control Switches

- Ø16
- Ø22/25
- Ø30
- 30

Push Button Switches

- Round
- Square
- Rectangular

Selector Switches

- Round
- Square
- Rectangular

Key Selector Switches

- Round
- Square
- Rectangular

Double Push Button Switches

Mushroom-head Push Button Switches

Emergency Switches

Pilot Lights

Accessories

B buzzers

A Accessories

Switch Enclosures for Ø22/25 Control Switches

Ordering Information

SA		SB	3	
Item	Applied switches	Appearance	Holes	
			1	1 hole
			2	2 holes
			3	3 holes
			4	4 holes
Item	Applied switches	Appearance	SB	Square type
			TB	Triangle type
			No-mark	For Ø22/25 control switches
SA			Switch accessories	



※You can order the other size and the number of holes.

• Hole size: Ø22.5/25.5mm

(unit: mm)

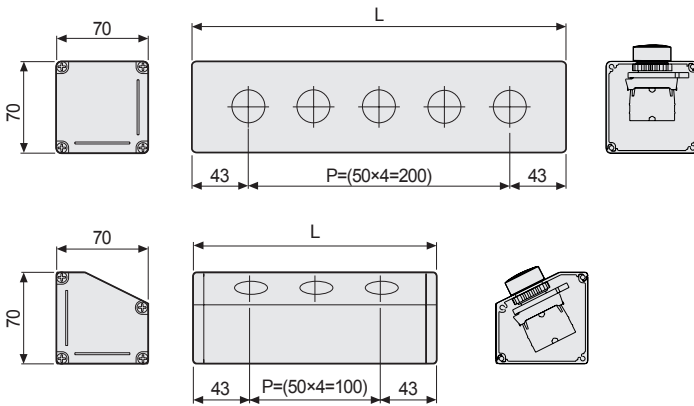

Holes	L
1	86mm
2	136mm
3	186mm
4	236mm
5	286mm













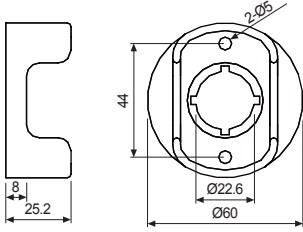

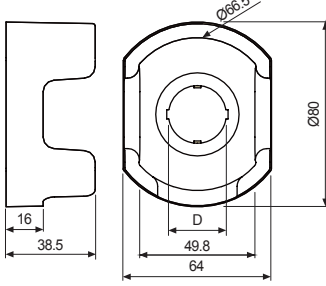
Locking Handle for Switches

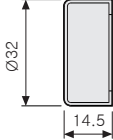
Applied switches	Appearance	Model	Note
Ø16		SA16-LH	For locking switch nuts behind the panels
Ø22/25, Ø30 ^{※1} , □30		SA-LH	

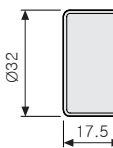
※1. Except Ø30 round pressure switches (extended).

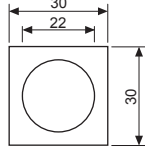
Accessories By Item

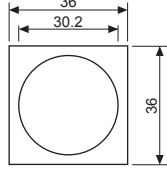
(unit: mm)

Item	Appearance	Model	Dimensions	Note						
Emergency switch nameplates		SA-NS	Size: D60×d25	Standard and illuminated nameplates are available for emergency switches. ※Illuminated nameplates are optional. ※D60 emergency switches (S2ER-E5R□) are not compatible with SA-NS nameplates						
		SA-NL	Size: D80×d25							
Protective shrouds for emergency switches		SA-EG1		Protective shrouds to prevent accidental/incorrect operation <table border="1" style="margin-left: 20px;"><tr><th>D</th><th></th></tr><tr><td>SA-EG2</td><td>Ø22.5</td></tr><tr><td>SA-EG3</td><td>Ø25.5</td></tr></table> ※Not available for D60 emergency switches (S2ER-E5R□).	D		SA-EG2	Ø22.5	SA-EG3	Ø25.5
	D									
SA-EG2	Ø22.5									
SA-EG3	Ø25.5									
		SA-EG2/ SA-EG3								
Waterproof cap for Ø22/25 round push button switches		SA-WP (non-illuminated/ extended)		IP65 protection structure with waterproof cap						
	 (extended)	SA-WL (illuminated/ extended)								
Ø20/25 Switch washer		SA-SW2		The washer helps to improve switch tightening force.						
Ø30 Switch washer		SA-SW3								
Lens remover for Ø16 push button control switches or pilot lights		SA16-RM		Lens remover for push button control switches or pilot lights						

Control Switches

Ø16

Ø22/25

Ø30

□30

Push Button Switches

Round

Square

Rectangular

Selector Switches

Round

Square

Rectangular

Key Selector Switches

Round

Square

Rectangular

Double Push Button Switches

Mushroom-head Push Button Switches

Emergency Switches

Pilot Lights

Accessories

B buzzers